

Future, made by us.

Pure⁺
Steel

Carbon Footprints

pure-steel.com

DILLINGER®



SHS - STAHL - HOLDING - SAAR

saarstahl

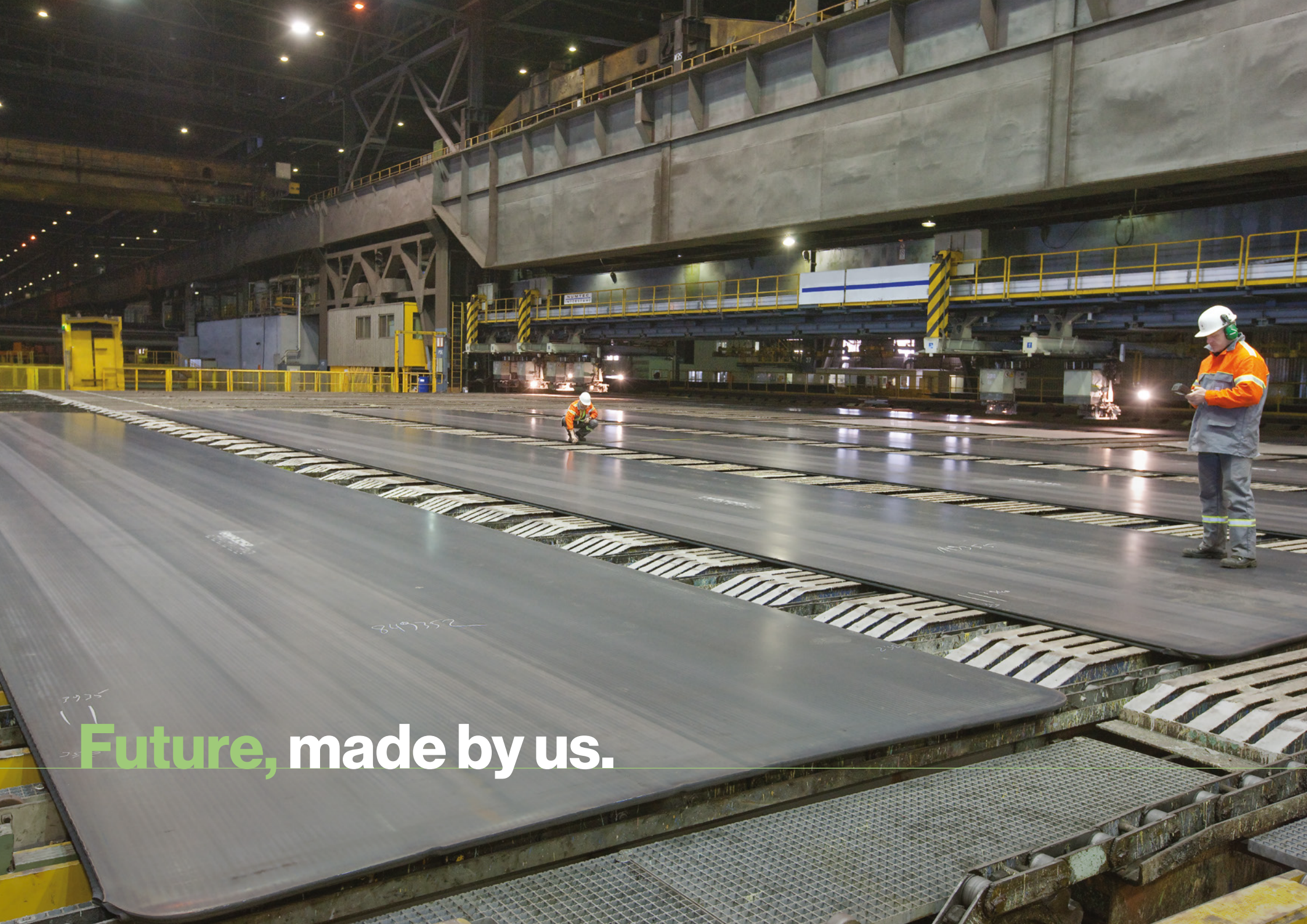

Future, made by us.

**SHS – Stahl-Holding-Saar
and its corporate groups
Dillinger and Saarstahl
are firmly committed to
the objectives of the Paris
Climate Agreement.**

In its comprehensive sustainability concept, SHS is standing by its responsibility for today's employees and stakeholders as well as for future generations. Consequently, sustainable production of high-quality steel products is a primary objective for the Group.

SHS is consistently pursuing its reduction strategy as part of a long-term environmental policy, in the course of which the company has already implemented innovative technologies for carbon reduction. The company has already achieved demonstrable improvements in environmental protection and energy efficiency with investments of around EUR 700 million in the last 15 years alone.

With the SHS Carbon Footprints, SHS is increasing its transparency with respect to its customers, employees and other stakeholders and is documenting its strategic path to carbon-neutral steel production.

SHS has ambitious goals for the future: with its transformation project Pure Steel+, SHS is aiming to produce carbon-neutral steel by 2045. The first phase of the project aims to already cut carbon emissions by 55% by 2030.

Corporate Carbon Footprint (CCF)

Diagram showing the reported scopes

SHS uses its Corporate Carbon Footprint (CCF) to report the comprehensive carbon footprint (carbon input-output balance) of direct and indirect greenhouse gas emissions at the corporate level.

Reporting is based on the standard **DIN EN ISO 14064** and the Greenhouse Gas (GHG) Protocol. These standards are used worldwide for organizations, governments, project applicants, and other stakeholders. DIN certification serves to ensure clear, uniform reporting with regard to the following aspects:

- + Quantitative measurement
- + Monitoring
- + Validation/verification of greenhouse gas balances (carbon footprints) or climate protection projects

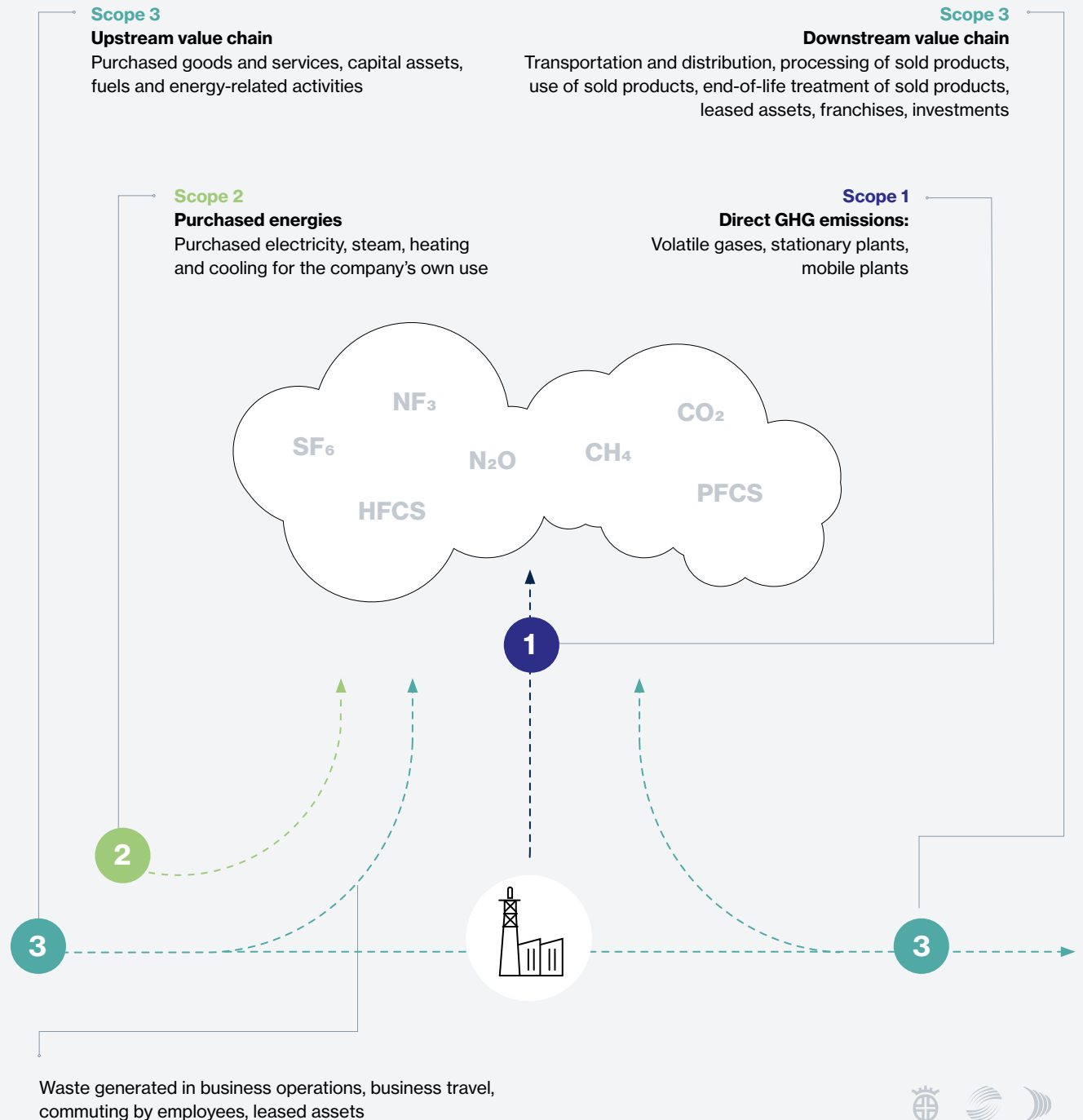

Corporate Carbon Footprint (CCF)

SHS Scope categories considered

Scope 1 (total):

- + Input materials
(including coal, ore, scrap, aggregates)
- + Fuel supply (natural gas, fuel oil and liquid gas)
- + Coolant consumption
- + Internal traffic and transport
- + Business trips with company vehicles

Scope 2 (total):

- + External power supply
- + District heating supply

Scope 3* (upstream):

- + Employee commuting
- + Business trips
(airplanes and rental vehicles)
- + Transport emissions for raw materials
- + Fuel and energy-related activities

Total
9.220.379 t

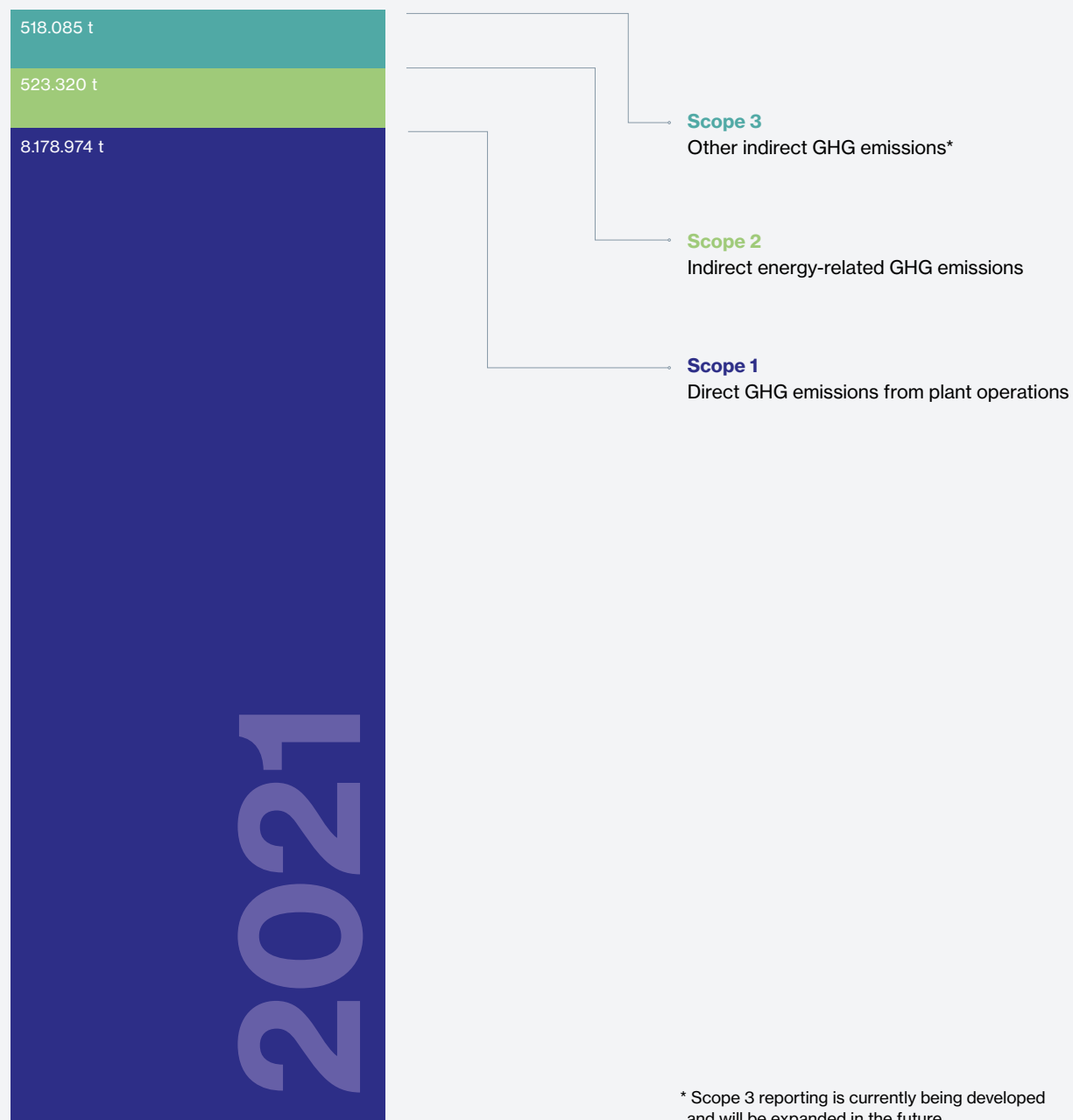

* Scope 3 reporting is currently being developed and will be expanded in the future.



Our “plus” for a clean tomorrow

Determining the respective Product Carbon Footprints

Calculation of the respective footprints was carried out by Sphera (formerly thinkstep) on the basis of the DIN EN ISO 14067 standard and the IPCC AR6 GWP 100 standard.

Sphera, a company with years of experience in the construction, automotive and steel sectors and developer of the life cycle assessment software GaBi*, is an excellent strategic partner for SHS.

The footprints for specific products are prepared using complex models – including the blast furnace gas flows between the individual production sites. SHS is consistently pursuing its reduction strategy as part of a long-term environmental policy, during the course of which the company has already implemented innovative technologies for carbon reduction.

The calculation includes the direct and indirect product-specific emissions of the main product groups – wire rod, bar steel, rail and heavy plate – and is based on

- + the GHG emissions of the company's own facilities,
- + the GHG emissions from the consumption of purchased energy and
- + default values (GaBi databases) for determining upstream chain emissions (Scope 3).

*GaBi is a life cycle database operated by Sphera.

Product Carbon Footprint (PCF) via the blast furnace route

SHS uses its Product Carbon Footprints (PCFs) to report the specific carbon emissions for the three main product groups of its Dillinger and Saarstahl brands: heavy plate, wire rod and bar steel.

From the mining of raw materials through to the rolled steel product, the approach describes the “cradle-to-gate” analysis. This analysis takes into account the entire process chain – starting from the extraction of raw materials from the earth (the “cradle”) and their transport, through the manufacture of intermediate products, and to the production of end products.

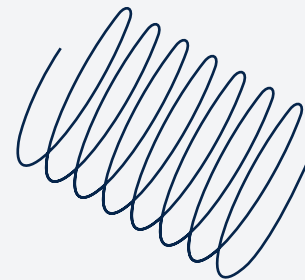
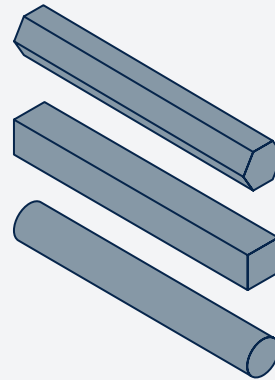
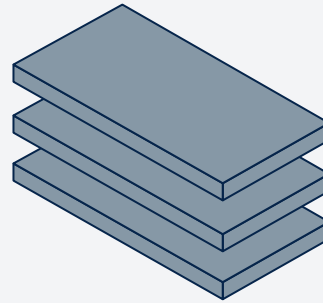

Heavy plate
(Dillingen, Dunkerque) via BF/BOF



Bar steel
(Völklingen, Neunkirchen) via BF/BOF



Wire rod
(Burbach, Neunkirchen) via BF/BOF

Scope 1 and Scope 2 Scope 3 (upstream) Total (all scopes)

* Any deviations are due to rounding differences.
* kg CO₂ eq./kg product



Partial PCF verified according to DIN ISO 14067
in line with the specifications of DIN ISO 14064-3.

Product Carbon Footprint (PCF) via the secondary route

Pure Steel+: The transformation starts with our high-quality steels from the secondary route

Pure Steel+ involves both the transformation of the blast furnace converter route (BF/BOF) to the DRI-based electric arc furnace route (DRI-EAF) as well as the production of high-quality steels via the electric arc furnace route (EAF) that uses recycled materials. The Saarstahl Ascoval EAF site already supplies the product range for rail, wire rod and bar steel with input material that combines the usual high Saarstahl quality with reduced carbon emissions.

During the verification of our Pure Steel+ products from Ascoval, TÜV Süd has certified our values (based on primary data for Scope 1 and 2 as well as secondary data for Scope 3) in accordance with DIN ISO 14067, whereby the consideration of upstream Scope 3 emissions is particularly important. The presented values describe the average of the production in 2021 (products with < 5% alloy content).

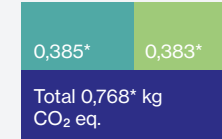
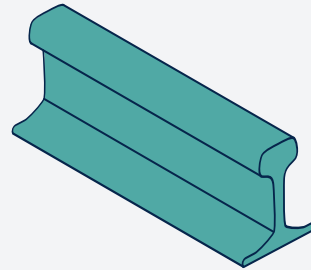

Rail
(Hayange) via EAF

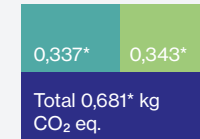
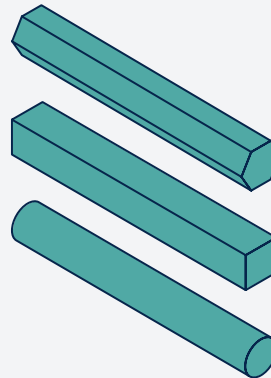

Bar steel
(Völklingen, Neunkirchen) via EAF

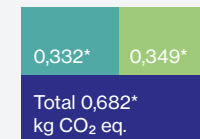
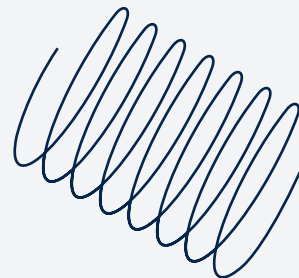

Wire rod
(Burbach, Neunkirchen) via EAF

Scope 1 and Scope 2 Scope 3 (upstream) Total (all scopes)

The Transformation Brand

Our path to green steel

We are tackling the biggest challenge in the history of Dillinger and Saarstahl: For the construction of state-of-the-art facilities for a decarbonized steel production, we plan to invest EUR 3.5 billion in the first phase in Saarland. Innovation and future in its purest form. Our brand: **Pure Steel+**.

We are investing in the future. “Pure” stands for the pure quality of our steel, which is already helping advance climate reversal today: Offshore wind turbines, green rail, electric mobility. At the same time, “Pure” also stands for a major step toward a greener and more sustainable world.

Our “plus” in the competition: We brand our decarbonized steel with the plus sign. To ensure that our customers around the world can immediately recognize the added value of our steel innovations, we assign it directly to our products.

A photograph of three offshore wind turbines in the ocean at sunset. The sky is a gradient of blue and orange, and the water is calm with reflections of the turbines. The text 'Pure+ Steel' is overlaid in the center in white.

Pure+
Steel



The transformation path is clearly defined.

On the path to carbon neutral

Our ambition: **to be climate neutral by 2045**. To this end, we are relying on the use of hydrogen, on electric steel production and on recycling steel scrap. From 2023 we will be starting with plans for construction of a **direct reduction plant** and two **electric arc furnaces (EAF)** at Dillingen and Völklingen. Starting in 2027/2028 we plan to produce up to 3.5 million tons of **green steel** per year. By 2030, we aim to cut CO₂ by up to 55%.

We are therefore transforming up to **70% of our production to climate-friendly** methods as a first step. We plan to **invest around EUR 3.5 billion**, but do need support in the form of public funding. Construction of a third EAF is being considered for a second phase to be completed by 2045, which would enable us to produce a total of **4.9 million metric tons of decarbonized crude steel per year**.

Current steel production

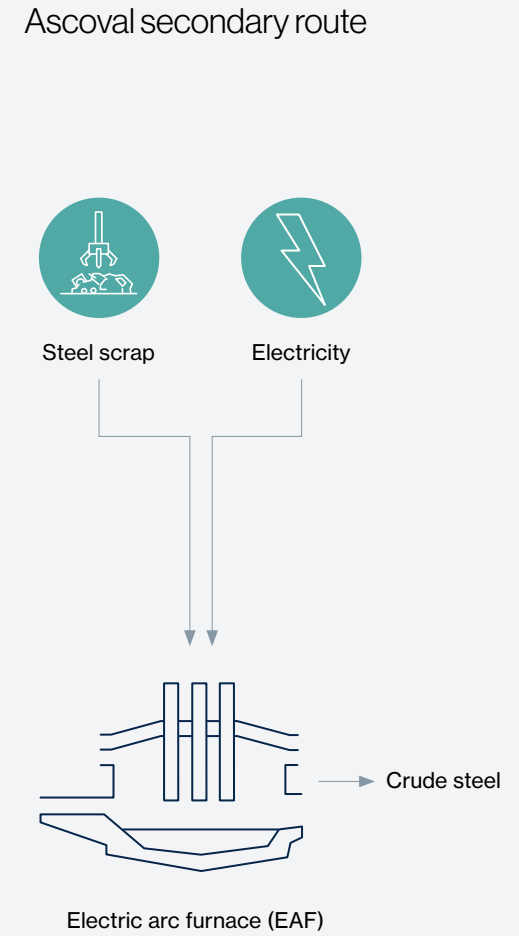
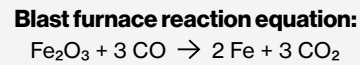
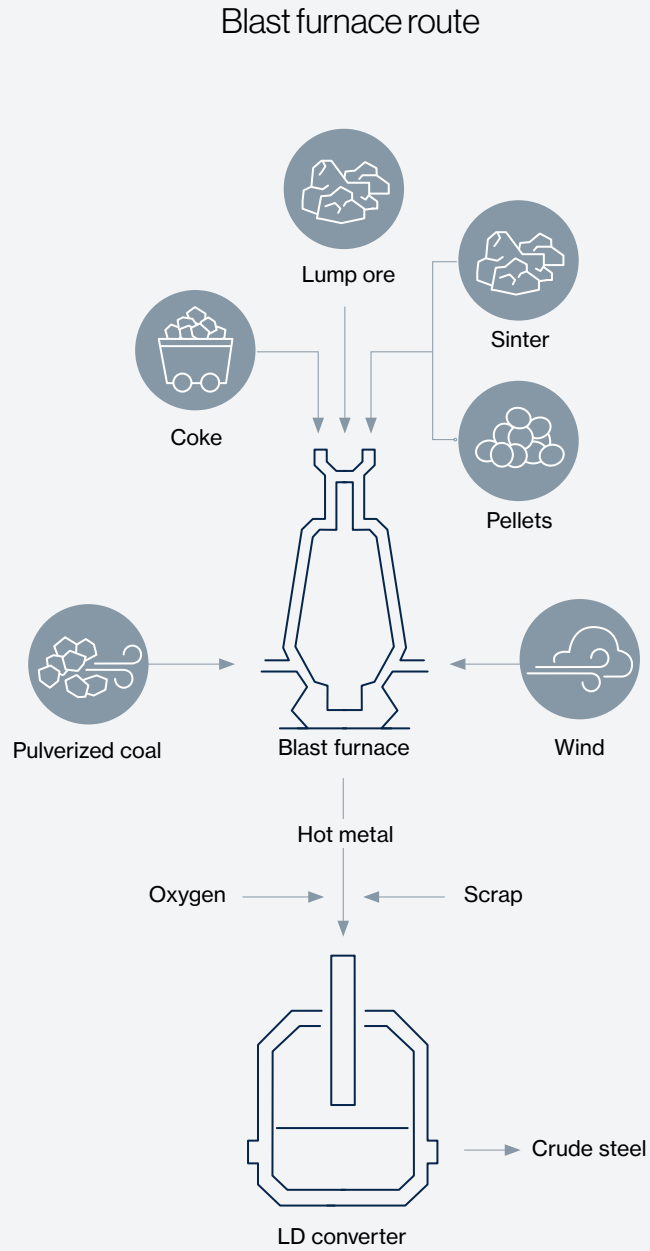

Planned new plants for the transformation in Saarland's steel industry

We will achieve the CO₂-emission targets by converting the technologies to direct-reduction and electric arc furnaces.

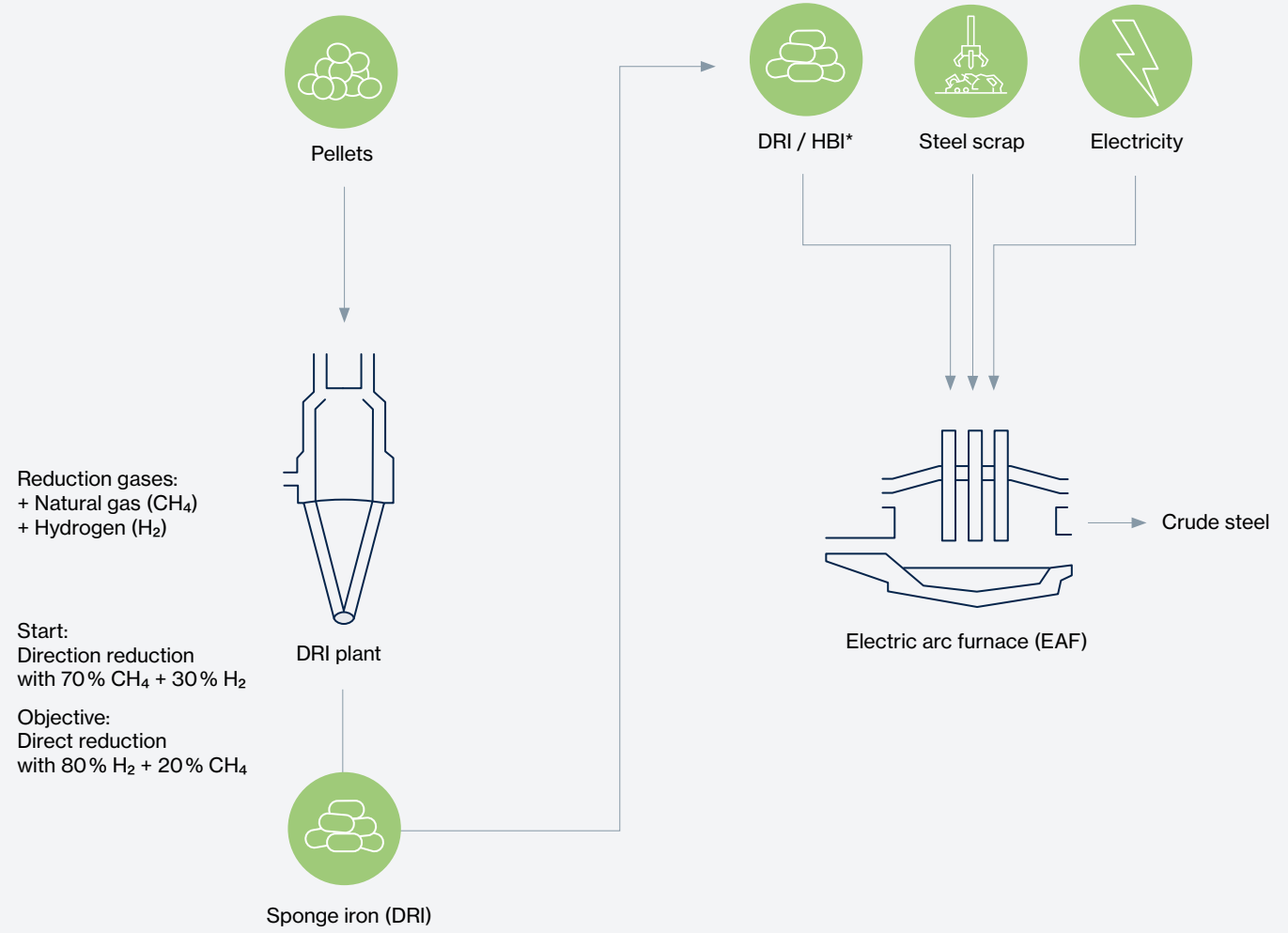

* Hot Briquetted Iron

If we don't, who will?

For more information:
www.pure-steel.com

Issued by:
SHS – Stahl-Holding-Saar GmbH & Co. KGa
Werkstraße 1 | 66763 Dillingen/Saar, Germany

Issued 2023, No. 1

